

LOCATION: Main St -- E 45th St
CITY/STATE: Vancouver, WA

QC JOB #: 13418629
DATE: Thu, Jun 11 2015

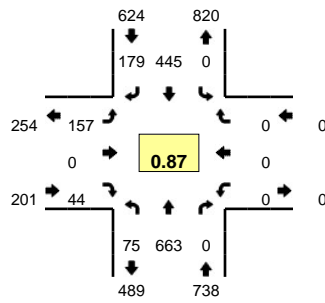

Peak-Hour: 4:25 PM -- 5:25 PM
Peak 15-Min: 5:00 PM -- 5:15 PM

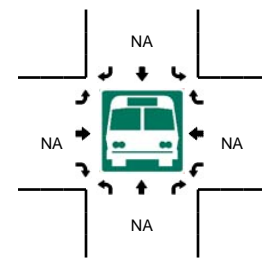
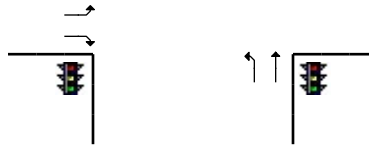
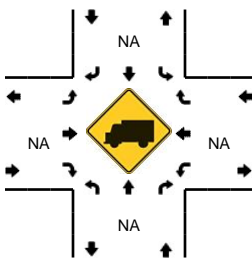
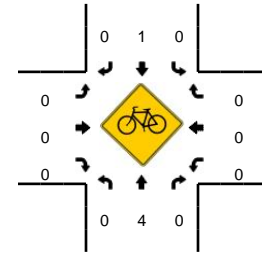
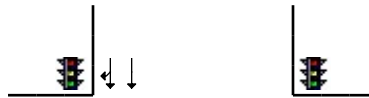
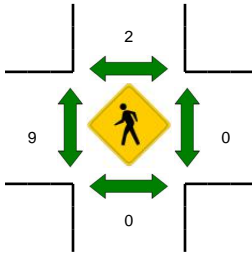
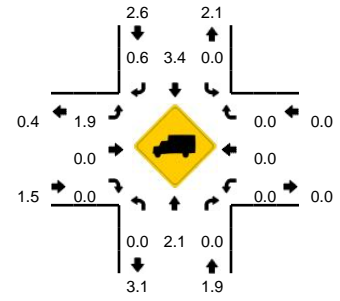

5-Min Count Period Beginning At	Main St (Northbound)				Main St (Southbound)				E 45th St (Eastbound)				E 45th St (Westbound)				Total	Hourly Totals
	Left	Thru	Right	U	Left	Thru	Right	U	Left	Thru	Right	U	Left	Thru	Right	U		
4:00 PM	6	51	0	0	0	45	7	0	12	0	5	0	0	0	0	0	126	
4:05 PM	1	57	0	0	0	43	18	0	10	0	6	0	0	0	0	0	135	
4:10 PM	9	55	0	0	0	43	16	0	16	0	1	0	0	0	0	0	140	
4:15 PM	6	67	0	0	0	41	12	0	11	0	3	0	0	0	0	0	140	
4:20 PM	6	41	0	0	0	41	15	0	14	0	3	0	0	0	0	0	120	
4:25 PM	7	65	0	0	0	33	17	0	13	0	5	0	0	0	0	0	140	
4:30 PM	4	40	0	0	0	42	15	0	5	0	1	0	0	0	0	0	107	
4:35 PM	2	58	0	0	0	30	12	0	10	0	2	0	0	0	0	0	114	
4:40 PM	2	55	0	0	0	32	9	0	21	0	4	0	0	0	0	0	123	
4:45 PM	7	51	0	0	0	36	14	0	11	0	5	0	0	0	0	0	124	
4:50 PM	5	44	0	0	0	41	8	0	13	0	4	0	0	0	0	0	115	
4:55 PM	3	40	0	0	0	45	21	0	10	0	0	0	0	0	0	0	119	1503
5:00 PM	8	59	0	0	0	35	15	0	10	0	3	0	0	0	0	0	130	1507
5:05 PM	6	82	0	0	0	41	22	0	16	0	5	0	0	0	0	0	172	1544
5:10 PM	13	58	0	0	0	39	13	0	20	0	3	0	0	0	0	0	146	1550
5:15 PM	7	56	0	0	0	30	13	0	18	0	4	0	0	0	0	0	128	1538
5:20 PM	11	55	0	0	0	41	20	0	10	0	8	0	0	0	0	0	145	1563
5:25 PM	9	52	0	0	0	33	13	0	10	0	8	0	0	0	0	0	125	1548
5:30 PM	2	33	0	0	0	41	18	0	18	0	1	0	0	0	0	0	113	1554
5:35 PM	4	38	0	0	0	31	12	0	9	0	6	0	0	0	0	0	100	1540
5:40 PM	6	51	0	0	0	43	17	0	12	0	5	0	0	0	0	0	134	1551
5:45 PM	9	37	0	0	0	37	16	0	9	0	5	0	0	0	0	0	113	1540
5:50 PM	7	50	0	0	0	44	15	0	13	0	5	0	0	0	0	0	134	1559
5:55 PM	4	48	0	0	0	39	5	0	21	0	5	0	0	0	0	0	122	1562
Peak 15-Min Flowrates	Northbound				Southbound				Eastbound				Westbound				Total	
	Left	Thru	Right	U	Left	Thru	Right	U	Left	Thru	Right	U	Left	Thru	Right	U		
All Vehicles	108	796	0	0	0	460	200	0	184	0	44	0	0	0	0	0	1792	
Heavy Trucks	0	24	0	0	0	8	4	0	0	0	0	0	0	0	0	0	36	
Pedestrians		0				0				8				0			8	
Bicycles	0	0	0		0	0	0		0	0	0		0	0	0		0	
Railroad																		
Stopped Buses																		

Comments: N/A