

**LOCATION:** Main St -- W 15th St  
**CITY/STATE:** Vancouver, WA

**QC JOB #:** 13418616  
**DATE:** Thu, Jun 11 2015

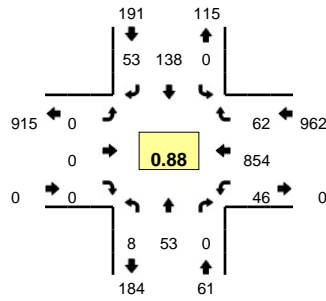

**Peak-Hour: 7:40 AM -- 8:40 AM**  
**Peak 15-Min: 7:45 AM -- 8:00 AM**

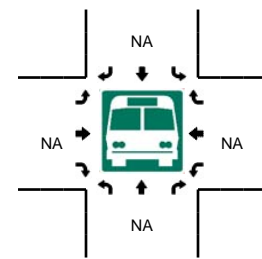
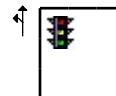
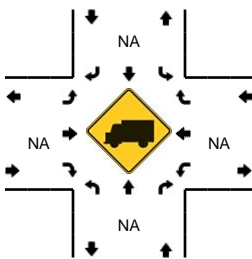
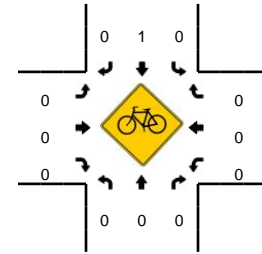
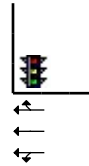
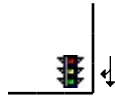
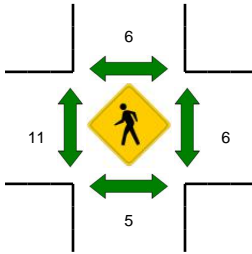
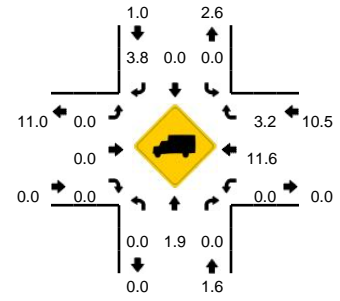

5-Min Count Period Beginning At	Main St (Northbound)				Main St (Southbound)				W 15th St (Eastbound)				W 15th St (Westbound)				Total	Hourly Totals
	Left	Thru	Right	U	Left	Thru	Right	U	Left	Thru	Right	U	Left	Thru	Right	U		
7:00 AM	2	1	0	0	0	14	0	0	0	0	0	0	1	44	0	0	62	
7:05 AM	2	2	0	0	0	15	6	0	0	0	0	0	1	44	2	0	72	
7:10 AM	0	1	0	0	0	18	4	0	0	0	0	0	2	41	4	0	70	
7:15 AM	1	3	0	0	0	17	8	0	0	0	0	0	2	63	3	0	97	
7:20 AM	0	1	0	0	0	12	3	0	0	0	0	0	4	59	1	0	80	
7:25 AM	0	3	0	0	0	15	2	0	0	0	0	0	3	62	2	0	87	
7:30 AM	1	0	0	0	0	8	10	0	0	0	0	0	0	42	2	0	63	
7:35 AM	0	4	0	0	0	19	7	0	0	0	0	0	0	60	0	0	90	
7:40 AM	0	3	0	0	0	14	6	0	0	0	0	0	5	62	2	0	92	
7:45 AM	1	1	0	0	0	16	6	0	0	0	0	0	3	75	4	0	106	
7:50 AM	2	1	0	0	0	23	6	0	0	0	0	0	4	72	8	0	116	
7:55 AM	1	5	0	0	0	10	8	0	0	0	0	0	2	91	7	0	124	1059
8:00 AM	1	6	0	0	0	9	3	0	0	0	0	0	8	71	5	0	103	1100
8:05 AM	0	4	0	0	0	9	5	0	0	0	0	0	2	80	7	0	107	1135
8:10 AM	0	2	0	0	0	9	1	0	0	0	0	0	1	63	7	0	83	1148
8:15 AM	1	7	0	0	0	10	4	0	0	0	0	0	10	64	2	0	98	1149
8:20 AM	0	4	0	0	0	12	5	0	0	0	0	0	4	65	4	0	94	1163
8:25 AM	2	5	0	0	0	10	2	0	0	0	0	0	2	71	7	0	99	1175
8:30 AM	0	10	0	0	0	10	3	0	0	0	0	0	3	71	4	0	101	1213
8:35 AM	0	5	0	0	0	6	4	0	0	0	0	0	2	69	5	0	91	1214
8:40 AM	1	5	0	0	0	4	3	0	0	0	0	0	7	63	4	0	87	1209
8:45 AM	0	7	0	0	0	11	2	0	0	0	0	0	7	52	2	0	81	1184
8:50 AM	2	3	0	0	0	14	1	0	0	0	0	0	8	67	6	0	101	1169
8:55 AM	3	0	0	0	0	10	2	0	0	0	0	0	13	68	3	0	99	1144
Peak 15-Min Flowrates	Northbound				Southbound				Eastbound				Westbound				Total	
	Left	Thru	Right	U	Left	Thru	Right	U	Left	Thru	Right	U	Left	Thru	Right	U		
All Vehicles	16	28	0	0	0	196	80	0	0	0	0	0	36	952	76	0	1384	
Heavy Trucks	0	0	0	0	0	0	0	0	0	0	0	0	0	88	0	0	88	
Pedestrians		8				8				8				8			32	
Bicycles	0	0	0		0	0	0		0	0	0		0	0	0		0	
Railroad																		
Stopped Buses																		

Comments: N/A