

LOCATION: NE 137th Ave -- NE Fourth Plain Rd
CITY/STATE: Vancouver, WA

QC JOB #: 14655102
DATE: Wed, Mar 21 2018

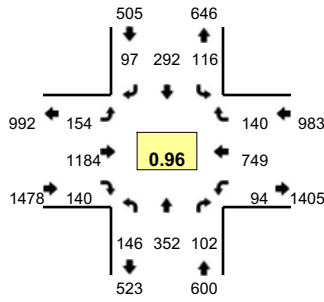

Peak-Hour: 4:30 PM -- 5:30 PM
Peak 15-Min: 4:40 PM -- 4:55 PM

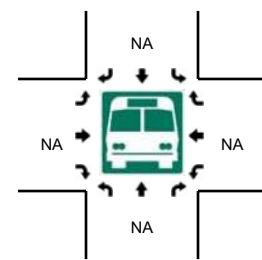
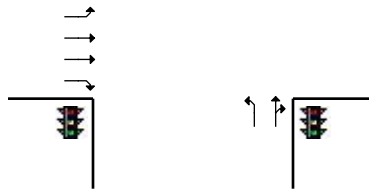
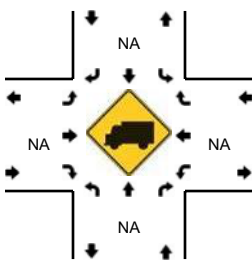
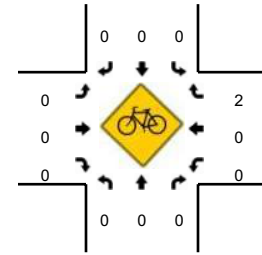
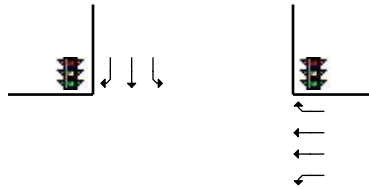
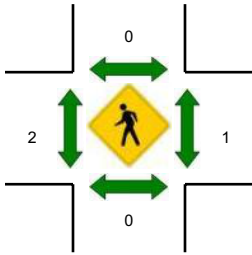
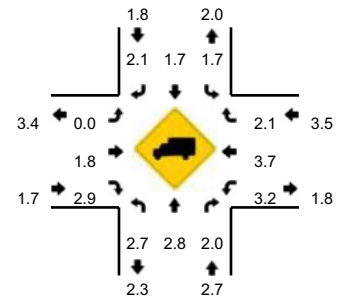

5-Min Count Period Beginning At	NE 137th Ave (Northbound)				NE 137th Ave (Southbound)				NE Fourth Plain Rd (Eastbound)				NE Fourth Plain Rd (Westbound)				Total	Hourly Totals
	Left	Thru	Right	U	Left	Thru	Right	U	Left	Thru	Right	U	Left	Thru	Right	U		
4:00 PM	11	28	9	0	8	18	16	0	8	77	13	0	3	50	9	1	251	
4:05 PM	15	22	7	0	14	22	8	0	14	99	12	0	7	67	8	0	295	
4:10 PM	8	27	10	0	3	25	5	0	14	107	10	0	11	62	11	0	293	
4:15 PM	13	29	9	0	9	20	10	0	13	98	7	0	13	61	12	0	294	
4:20 PM	13	33	12	0	10	24	5	0	18	80	14	0	9	68	14	0	300	
4:25 PM	12	20	9	0	8	11	14	0	10	103	2	0	15	67	8	0	279	
4:30 PM	11	27	6	0	6	28	13	0	10	107	12	0	9	75	14	0	318	
4:35 PM	12	28	16	0	9	31	9	0	21	74	11	0	8	52	8	0	279	
4:40 PM	11	29	7	0	11	18	9	0	18	116	15	0	5	72	6	0	317	
4:45 PM	13	29	12	0	6	22	8	0	11	97	17	0	6	74	14	0	309	
4:50 PM	11	28	8	0	7	22	8	0	10	106	11	0	7	70	13	0	301	
4:55 PM	13	26	10	0	10	17	11	0	17	88	7	0	6	54	8	1	268	3504
5:00 PM	7	26	12	0	10	15	9	0	4	100	14	0	4	60	19	0	280	3533
5:05 PM	8	20	3	0	9	26	5	0	18	116	13	0	11	64	8	1	302	3540
5:10 PM	15	35	7	0	11	27	5	0	8	89	7	0	11	56	7	1	279	3526
5:15 PM	19	39	4	0	11	30	7	0	15	89	10	0	9	62	17	0	312	3544
5:20 PM	14	28	8	0	17	28	8	0	11	107	15	0	6	58	13	0	313	3557
5:25 PM	12	37	9	0	9	28	5	0	11	95	8	0	9	52	13	0	288	3566
5:30 PM	7	28	4	0	11	27	8	0	12	105	9	0	10	59	13	0	293	3541
5:35 PM	10	22	1	0	9	27	16	0	18	102	15	0	7	38	6	0	271	3533
5:40 PM	12	29	5	0	9	24	8	0	19	93	9	0	12	76	8	0	304	3520
5:45 PM	10	32	9	0	5	22	13	0	15	101	9	0	8	62	12	0	298	3509
5:50 PM	16	22	5	0	11	20	8	0	14	100	7	0	6	37	11	0	257	3465
5:55 PM	9	23	5	0	15	14	5	0	11	94	7	0	4	60	8	0	255	3452
Peak 15-Min Flowrates	Northbound				Southbound				Eastbound				Westbound				Total	
	Left	Thru	Right	U	Left	Thru	Right	U	Left	Thru	Right	U	Left	Thru	Right	U		
All Vehicles	140	344	108	0	96	248	100	0	156	1276	172	0	72	864	132	0	3708	
Heavy Trucks	4	8	8		0	4	8		0	8	4		0	44	4		92	
Pedestrians		0				0				0				0			0	
Bicycles		0	0			0	0	0		0	0	0		0	0	2	2	
Railroad																		
Stopped Buses																		

Comments: