

LOCATION: NE Ward Rd/NE 147th Ave -- NE Fourth Plain Rd
CITY/STATE: Vancouver, WA

QC JOB #: 14655105
DATE: Wed, Mar 21 2018

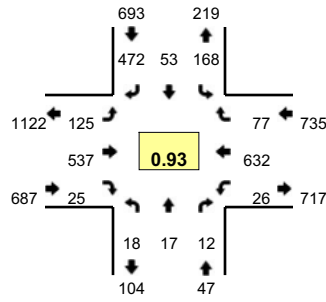

Peak-Hour: 7:25 AM -- 8:25 AM
Peak 15-Min: 7:25 AM -- 7:40 AM

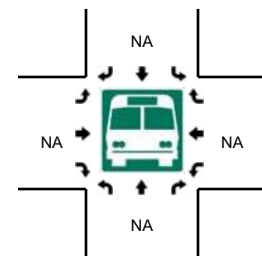
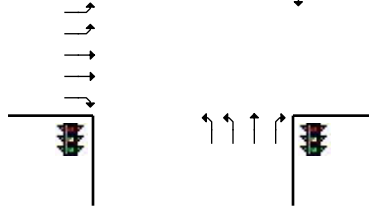
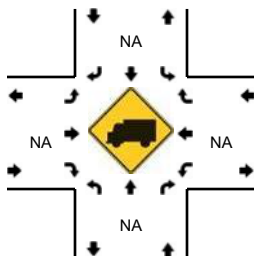
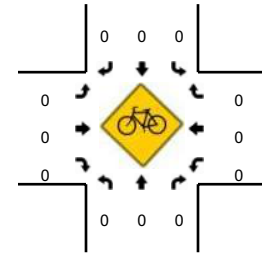
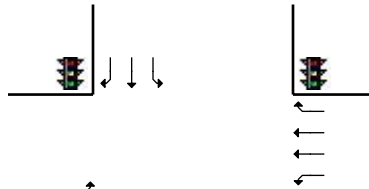
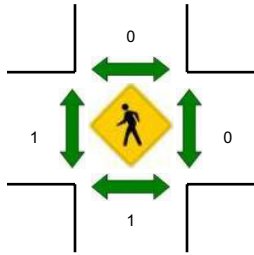
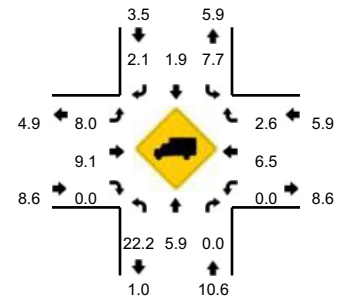

5-Min Count Period Beginning At	NE Ward Rd/NE 147th Ave (Northbound)				NE Ward Rd/NE 147th Ave (Southbound)				NE Fourth Plain Rd (Eastbound)				NE Fourth Plain Rd (Westbound)				Total	Hourly Totals
	Left	Thru	Right	U	Left	Thru	Right	U	Left	Thru	Right	U	Left	Thru	Right	U		
7:00 AM	0	0	0	0	1	1	40	0	7	32	2	0	0	36	2	0	121	
7:05 AM	0	1	0	0	8	2	37	0	4	29	1	0	1	37	3	0	123	
7:10 AM	2	2	2	0	5	3	31	0	8	32	1	0	2	40	1	0	129	
7:15 AM	3	3	2	0	15	2	41	0	6	37	1	0	1	42	3	0	156	
7:20 AM	0	0	0	0	8	4	45	0	14	43	0	0	0	56	2	0	172	
7:25 AM	3	3	2	0	18	3	46	0	6	60	2	0	4	47	4	0	198	
7:30 AM	0	0	1	0	15	7	52	0	20	36	1	0	0	53	5	0	190	
7:35 AM	1	2	2	0	18	4	44	0	7	50	1	0	1	62	4	0	196	
7:40 AM	1	2	1	0	19	5	28	0	15	48	4	0	1	59	2	0	185	
7:45 AM	0	1	3	0	18	5	48	0	7	55	3	0	1	52	3	0	196	
7:50 AM	3	1	1	0	17	4	35	0	17	47	2	0	4	45	12	0	188	
7:55 AM	1	3	1	0	9	3	27	0	11	54	3	0	6	53	4	0	175	2029
8:00 AM	0	2	1	0	8	5	36	0	12	42	4	0	1	51	10	0	172	2080
8:05 AM	1	1	0	0	15	7	30	0	4	31	0	0	2	48	9	0	148	2105
8:10 AM	2	2	0	0	10	3	43	0	14	36	2	0	1	55	9	0	177	2153
8:15 AM	0	0	0	0	10	3	33	0	6	41	0	0	3	53	8	0	157	2154
8:20 AM	6	0	0	0	11	4	50	0	6	37	3	0	2	54	7	0	180	2162
8:25 AM	5	1	2	0	10	6	34	0	9	36	1	0	2	44	8	0	158	2122
8:30 AM	1	2	1	0	14	6	42	0	16	43	2	0	2	52	6	0	187	2119
8:35 AM	5	2	2	0	11	2	38	0	10	33	2	0	0	41	5	0	151	2074
8:40 AM	4	2	2	0	9	3	33	0	6	45	4	0	3	60	3	0	174	2063
8:45 AM	4	1	2	0	12	2	37	1	7	44	0	0	1	43	5	0	159	2026
8:50 AM	1	1	4	0	12	12	35	0	8	29	0	0	3	37	5	0	147	1985
8:55 AM	2	1	1	0	13	2	23	0	2	38	1	0	2	42	6	0	133	1943
Peak 15-Min Flowrates	Northbound				Southbound				Eastbound				Westbound				Total	
	Left	Thru	Right	U	Left	Thru	Right	U	Left	Thru	Right	U	Left	Thru	Right	U		
All Vehicles	16	20	20	0	204	56	568	0	132	584	16	0	20	648	52	0	2336	
Heavy Trucks	4	0	0		12	0	12		0	84	0		0	24	8		144	
Pedestrians		0				0				0				0			0	
Bicycles	0	0	0		0	0	0		0	0	0		0	0	0		0	
Railroad																		
Stopped Buses																		

Comments: